

CHAPTER FIVE

Falsework and Forms

CONTENTS

INTRODUCTION	5-2
FALSEWORK AND FORMS	5-2
Falsework	5-3
Braces and Ties	5-5
Forms	5-8
Checking Forms for Workmanship	5-14
INSPECTING FORMS FOR DIMENSIONS, GRADES AND ALIGNMENT	5-18
REMOVAL OF FALSEWORK AND FORMS	5-24
ANSWERS TO QUESTIONS	5-26

5

FALSEWORK AND FORMS

INTRODUCTION

In this chapter, we will cover the use of falsework and forms. Since the concrete work is similar for both box culverts and bridges, we will make distinctions only where methods or requirements conflict.

As an Inspector, you are responsible for inspecting all concrete construction operations from building falsework to finishing concrete surfaces. In this phase of structures inspection, you will depend heavily upon the contract plans, so do not hesitate to check them if you are in doubt about sizes, dimensions, etc.

FALSEWORK AND FORMS

Falsework and forms are erected together as temporary structures to hold and support fresh concrete, stabilize girders, and provide temporary support until the entire structure is self-supporting. Once cast in place concrete has gained enough strength to become self-supporting, some of the falsework and forms can usually be removed.

The Contractor is responsible for the design and construction of all falsework and forms. However, the Project Administrator may request that the Contractor submit the plans for constructing falsework and forms for review and when public safety is an issue, approval. Keep in mind that the Project Administrator's approval of the Contractor's falsework plans does not relieve the Contractor of the responsibility for properly designing, constructing and maintaining the falsework and forms.

As an Inspector, your responsibility includes the inspection of falsework so that the finished structure will meet all the requirements of the plan dimensions.

FALSEWORK

Falsework is any temporary structure used to support the forms for concrete. Falsework supports the forms until the concrete can support itself. It is essential that falsework be strong enough to support the weight of three things: the forms, the fresh concrete and any construction equipment and workers. Falsework also must be capable of maintaining the correct elevations. To do this, suitable jacks, wedges or other approved devices must be used as part of the falsework. These devices also will permit the falsework to be lowered gradually. In the illustration below, one type of falsework, temporary piers, is supporting the forms between the permanent piers.

The temporary piers can be metal or wood frameworks set on mudsills -- pieces of timber that rest on wide, rigid foundations (solid rock or piles). Concrete pedestals placed on the ground may be used as mudsills.

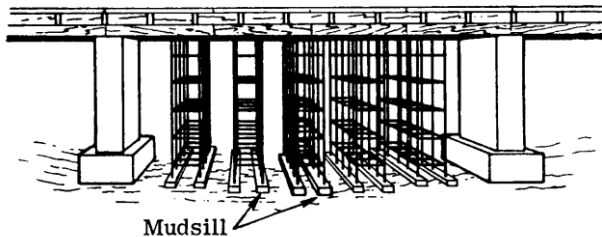

More recently, slip forms -- metal forms that roll along the slab -- have been used. Slip forms allow the same forms to be reused by loosening tension and rolling the forms to the next section of the box culvert.

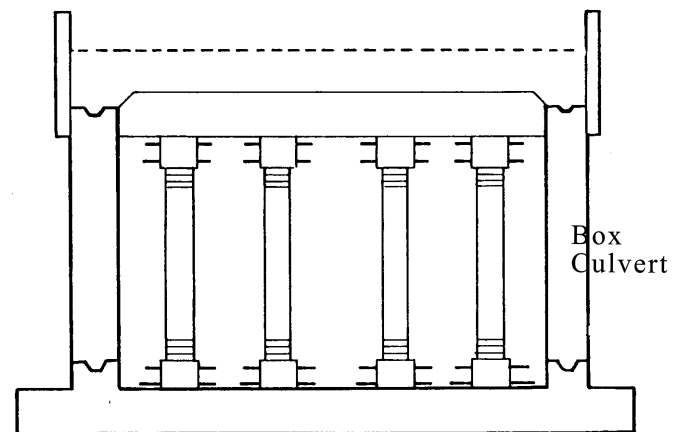



Typical Shoring for a Steel Girder Bridge

BRACES AND TIES

Braces and ties are smaller types of falsework and are used to hold forms in place. Look at the wood braces, walers and metal ties in the wall below:

In order to hold the forms in proper positions, all bracing should be rigid and must be firmly secured to the forms.

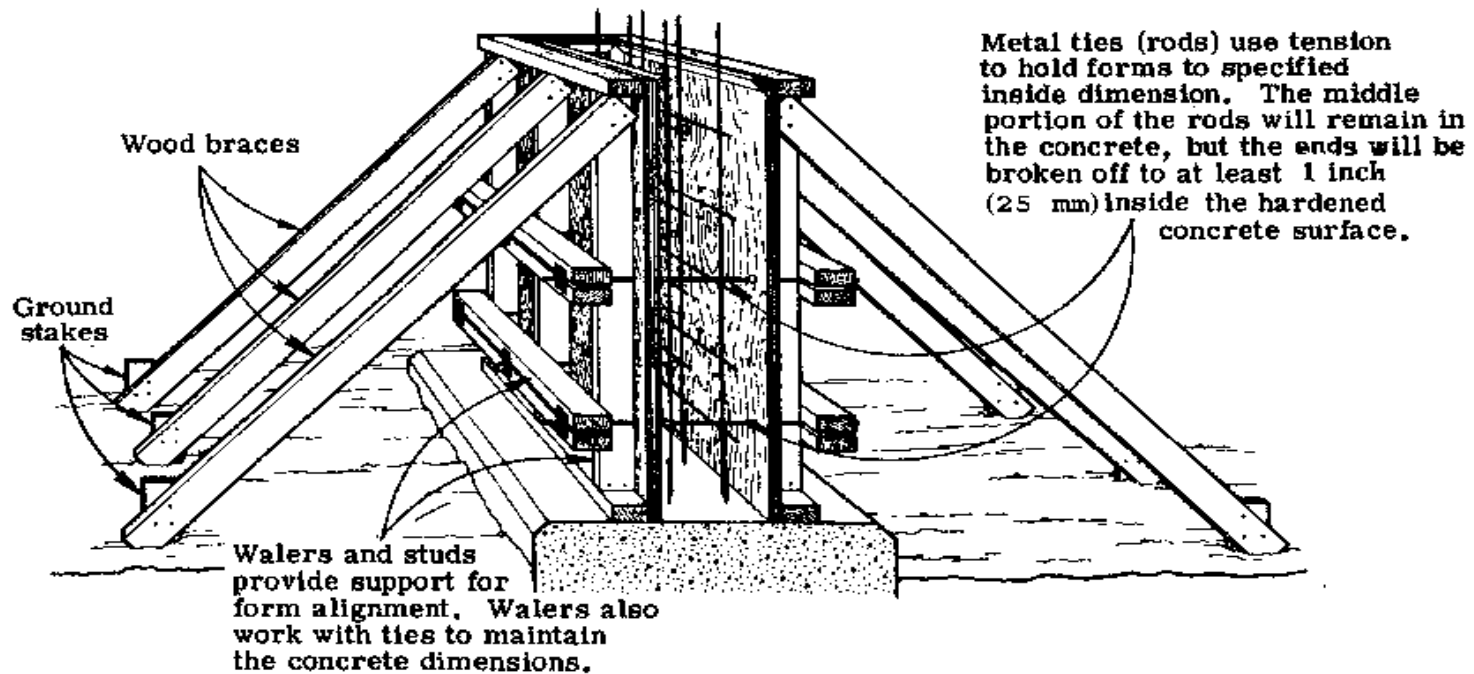

Falsework Piles

The mudsills under falsework must be properly supported or they will settle, causing the falsework to collapse. Sometimes temporary piles are used as the base for falsework. You should make a visual check while these temporary piles are being driven, to be sure that they encounter resistance.

When falsework piles are no longer needed, they must be removed. They should be completely pulled out or, if they remain, should be cut off below the ground level.

Collars

Collars -- another type of falsework -- are metal bands that fit around finished columns. They are used to support the forms needed to construct caps. The friction between the concrete and the bands holds them in place. If a collar does not fit the column, there is a chance that it could slip.

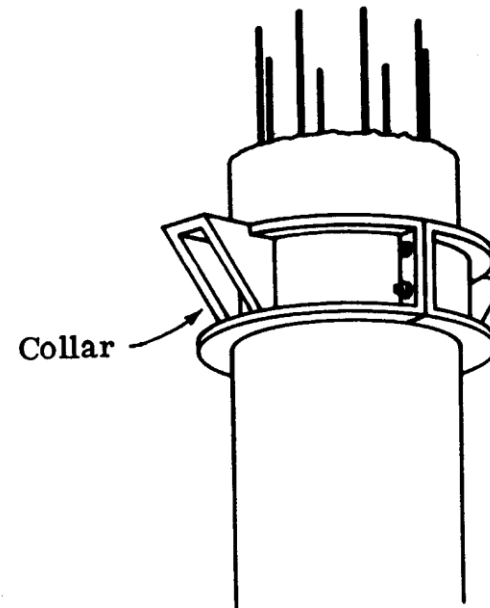

QUIZ

Concrete is held in position by _____ until it is strong enough to be self-supporting.

When necessary, concrete forms are supported by temporary structures called _____ .

Falsework usually is set on pieces of timber or concrete called _____.

What purpose do wood braces and metal ties serve? _____

What prevents collars from slipping? _____

To hold forms firmly in place, bracing should be _____.

Name three things which falsework must be strong enough to support:

Who is responsible for the design and construction of falsework?

Falsework must be adjustable to the correct _____. To do this, _____ or other suitable devices may be used.

Now go on to FORMS.

FORMS

Forms hold the plastic concrete in place until it gains enough strength to hold up itself. The forms must be strong enough to support the pressure and the weight of the fresh concrete and any construction loads such as finishing equipment and workers. In addition, the forms should be able to withstand the effects of vibration caused by vibrators that are used for consolidation.

It is especially important that you inspect the condition of the forms and how they are put together. If the job is not done correctly, the finished surfaces of the structure will be unsatisfactory. Especially for vertical walls, form surfaces must be strong enough to prevent deflection by the plastic concrete. Forms joints must also be tight enough to prevent concrete mortar from leaking between through the joint during placement.

Two types of release oil are used for forms -- paraffin-base oil for wooden forms, and petroleum-base oil for steel forms.

Material Requirements for Forms

Forms can be made of wood or metal. Whichever type of form is used, you should make sure it is constructed and shaped according to the lines and grades specified in the plans.

On the next page, study the requirements that are not usually listed in plans, but which are essential for proper forming.

The inside surfaces of the forms should be oiled, prior to erecting forms, with an oil which does not discolor the concrete. The form oil shall be applied before the reinforcing steel is placed, so that the necessary bond will not be affected. The forms shall be wetted with water just prior to the actual placement of the concrete.

Form joints should be mortar-tight. Be sure that wood forms are will construction to prevent joint from opeinng from lumber shrinkage.

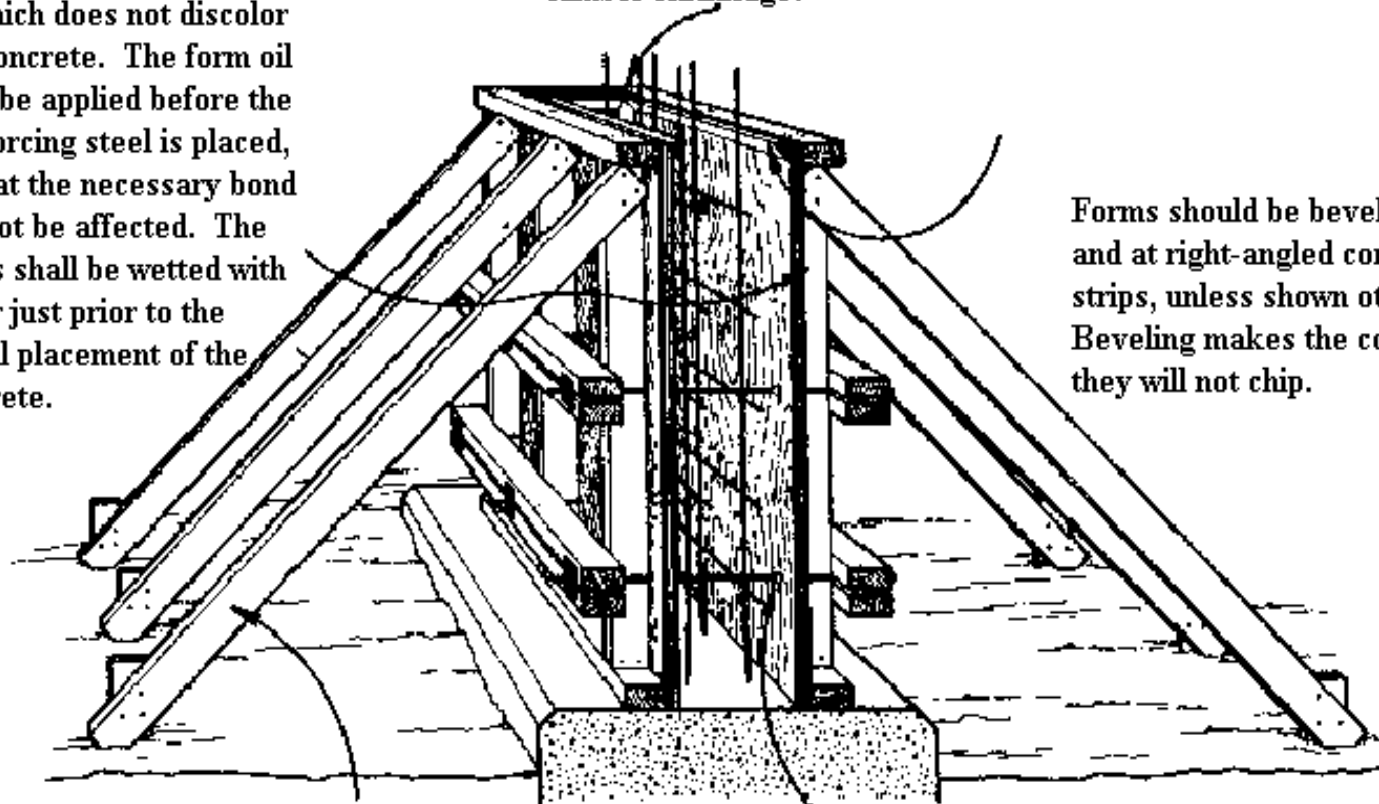

Forms should be beveled at exposed corners and at right-angled corners with chamfer strips, unless shown otherwise in the plans. Beveling makes the corners stronger and they will not chip.

Braces should be used to prevent buckling or displacing of forms.

Metal ties must be rods and must later be cut off at least 1 inch (25 mm) below the finished concrete surface.

Wood Forms

Wood is a commonly used form material. Generally, form faces are made of plywood that is braced by wooden studs. Wood forms for all exposed concrete surfaces should be made of lumber that is dressed and free of defects. When constructed, the forms should provide mortar-tight joints that produce smooth and even concrete surfaces.

Be sure to check the condition of the wood that is used as forming material. Lumber that is too dry will warp due to rain or the moisture in concrete. Lumber that is too green will shrink, causing joints to open in the surface.

Plywood forms, or forms face-lined with plywood can be used:

- if they are strong enough to resist bending.
- if they are of uniform thickness.
- if they will be mortar-tight when set in position.

One more point: forms for high walls must be built so that dirt and debris can be removed immediately prior to concrete placement. To accomplish this, the lower forms should be left loose for easy removal and replacement or a cleanout opening should be cut into one of the forms to allow cleaning to take place.

Metal Forms

In addition to wood forms, metal forms may be used. However, precautions must be taken to ensure that the following requirements are met before metal forms are used.

- The metal should be thick enough to hold its shape.
- All bolts and rivet heads must be countersunk to prevent them from marring the finished surface.
- Clamps, pins or other connecting devices should be designed to hold the forms rigidly together and to allow removal without damage to the concrete.

If you notice any metal forms that do not have smooth surfaces, are bent, or otherwise damaged and do not line up properly, have the Contractor remove them. Also you must be sure that the forms are free of corrosion, grease or other matter which would discolor the concrete.

Typical wooden and steel forms are pictured on the following page.



Timber Framing for a Pier Cap
Note the chamfer strip along the left edge



Steel Formwork for a Large Column
Note the form liners which produce architectural features on the finished product

QUIZ

In addition to supporting the pressure and the weight of fresh concrete and construction loads, forms should also be able to withstand the effects of _____.

How can the Contractor prevent wood forms from buckling during concrete placement? _____

What is the most important point about form joints that you must ensure? _____

The exposed corners of forms should be _____ with, _____, according to the plans.

What must be done to bolts and rivet heads used in metal forms? _____

List two reasons why clean form oil must be used to lubricate the inside of forms.

What will happen if lumber that is too green is used as forming material? _____

Why are right-angled corners beveled? _____

A wall 30 feet high, 12 feet long and 12 inches thick is being formed. How can you ensure that the bottom area between the forms will be cleaned? _____

When should the Contractor oil the forms for the wall described in the previous question? _____

CHECKING FORMS FOR WORKMANSHIP

The way the forms are built will determine to a large degree what the finished product will look like. If the Contractor does not fully comply with the plan requirements, the result may be a weak and badly constructed structural element. To ensure compliance with the plans, you should be sure the forms are built to the correct dimensions and elevations. Typical faulty work that would cause the wrong dimensions and elevations includes the following:

- Loose forms will cause movement of the forms after concrete placement allowing leaks like the one shown here.

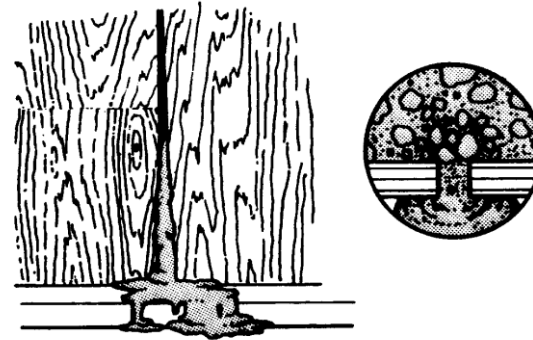

Large openings allow mortar to leak.

- Poorly supported forms will cause bulges in the finished surface if the forms come apart from lack of support. Examples of properly supported forms and poorly supported forms are shown below:

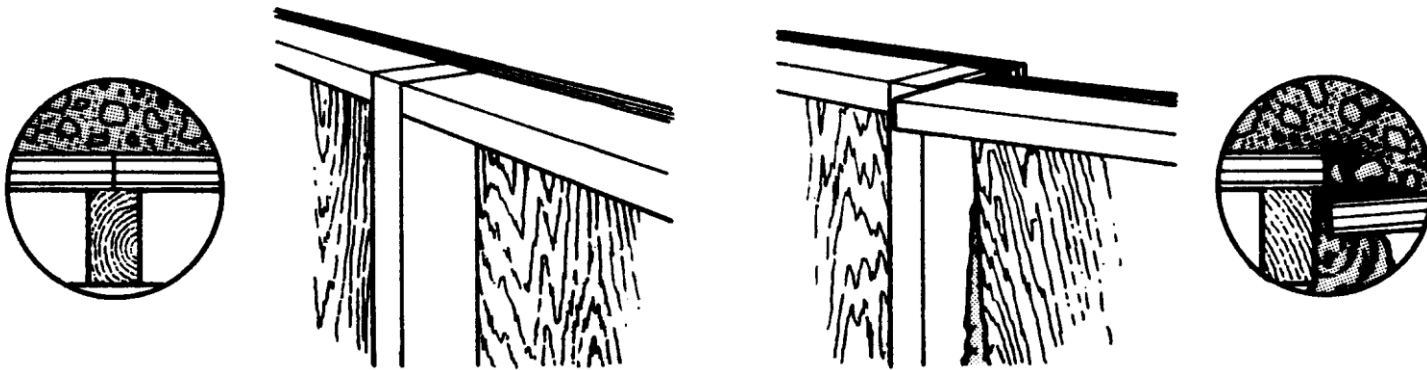

PROPERLY SUPPORTED

POORLY SUPPORTED

- You should be sure that supporting studs cover both forms, as in the example on the left -- not just one form, as in the example on the right.
- If forms are poorly aligned and not corrected before concrete is poured, the following results may occur:
 - Decreased concrete cover over reinforcement will cause reinforcement to corrode and concrete to spall with time.
 - Added dead weight in areas where the forms are too far apart will allow a wall or slab to be poured thicker than designed. Added weight may cause overstress in the reinforcing steel or foundation.
 - Poorly aligned forms will lead ultimately to a sloppy-looking job.

As an Inspector, you must be sure that any misaligned forms are realigned before concrete is placed. In most cases, this will involve minor adjustments of 2-inch or less.

- Frequent reuse of forming material should be avoided because it will cause:
 - rough finished surfaces.
 - difficulty in form removal.
 - possible form failure.
 - discoloration of the concrete, particularly if new and old forms are intermixed.
- If you discover any splintered or worn wooden forms or any bent metal forms, the Contractor must repair or replace them immediately.
- The improper use of form oil will cause the following problems:
 - The excessive use of form oil will discolor the concrete and possibly coat the steel -- resulting in a weak bond between steel and concrete.
 - Not enough form oil will increase the difficulty of form removal and will allow the wood forms to absorb water from the concrete.

If you see any of the problems described in this section, contact the Contractor immediately and ask that the situation be corrected. Any problems encountered should be discussed with your Project Administrator. You must be sure to learn from previous errors in order to prevent future errors. If any of the above problems arise during the first pour, be sure that you watch closely for the causes during forming for the next pours.

QUIZ

Loose forms cause form movement and gaps between the forms, which allow the concrete to _____.

Properly braced forms -- with joints fully supported -- are necessary to eliminate _____ in the finished surface.

Decreased concrete cover over reinforcement will cause reinforcement to _____ and concrete to _____.

After forms are removed, you discover blocks of discoloration. What is the probable cause?

If too little form oil is used, what problem will occur? _____

INSPECTING FORMS FOR DIMENSIONS, GRADES AND ALIGNMENT

Measurements should be taken often during forming to ensure that the Contractor builds forms that comply with the plans and specifications. Once the forms are completed and in place, you will have to measure all lengths, widths and heights and compare them with plan dimensions. These measurements are very important. There is no room for error since dimensional errors may result in the removal of concrete structures. By referring to the contract plans and by using a 6-foot rule or a tape measure, you should be able to take accurate measurements.

Inspecting the forms will require that you check the quality of workmanship in aligning the forms. A string line and a plumb bob will be useful to you for checking smooth lines -- vertical and horizontal. Also, since many parts of a structure must have pleasing appearances, you can "eyeball" many of the edges, such as the edges of parapets and curbs, and the exposed edges and corners or chamfers of rails, caps and columns.

Before concrete is placed, you must be sure that the grades and alignments are checked thoroughly by the Contractor's survey crew. You will be able to check some grades when you check dimensions by measuring up from known elevations of previously placed sections, but the survey crew still must check all the critical points on the forms for grades and alignment.

Here is the end view of a box culvert. The Contractor has jacks in place and forms set to place the top of the barrel. You are to inspect falsework and forms before work begins. Follow the checklist on the next page. What would you be looking for? Check what you would inspect.

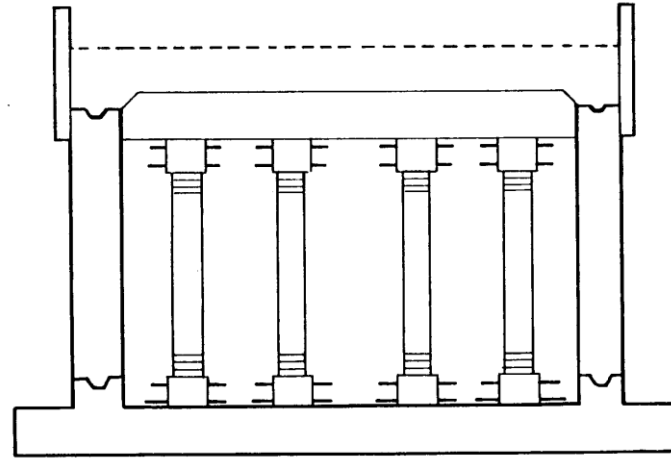

- ___ 1. Will the forms hold the weight and pressure of the wet concrete?
- ___ 2. Will vibrators affect the position of the forms?
- ___ 3. Will the materials used for forms be rigid and unbending enough?
- ___ 4. Are the joints "mortar-tight?"
- ___ 5. Are exposed corners of joints beveled or chamfered ?

- ___ 6. Are the supports properly spaced to avoid sagging of the forms?
- ___ 7. Should elevation or grade be checked?
- ___ 8. Should you compare dimensions of the forms -- length, width and depth -- to the plans?
- ___ 9. Do temperature and weather conditions enter in?
- ___ 10. Is the Contractor prepared to place the entire slab?

Look at the discussion below.

If you checked all ten, you understand your responsibility. Faulty judgment, here, could result in real problems. Replacing any slab would be costly and time consuming.

Remember -- when in doubt:

- LOOK AT THE PLANS
- REVIEW THE SPECIFICATIONS
- ASK QUESTIONS
- MEASURE AGAIN
- TALK TO THE CONTRACTOR

As we mentioned, when the forms are in place, the dimensions -- length, width and depth -- of that part of the structure should be checked to see that they agree with the plan requirements. But another consideration needs to be made for forms that are not totally supported, such as pier caps: what will happen to the forms when concrete is poured? Obviously, the forms will settle. To check against this, tattletales can be used.

Before concrete is placed, tattletales are suspended from the cap. Tattletales will indicate how much settlement, if any, takes place.

You should check and record the initial tattletale point. Then, as the concrete is placed, you must check the tattletales for any settlement.

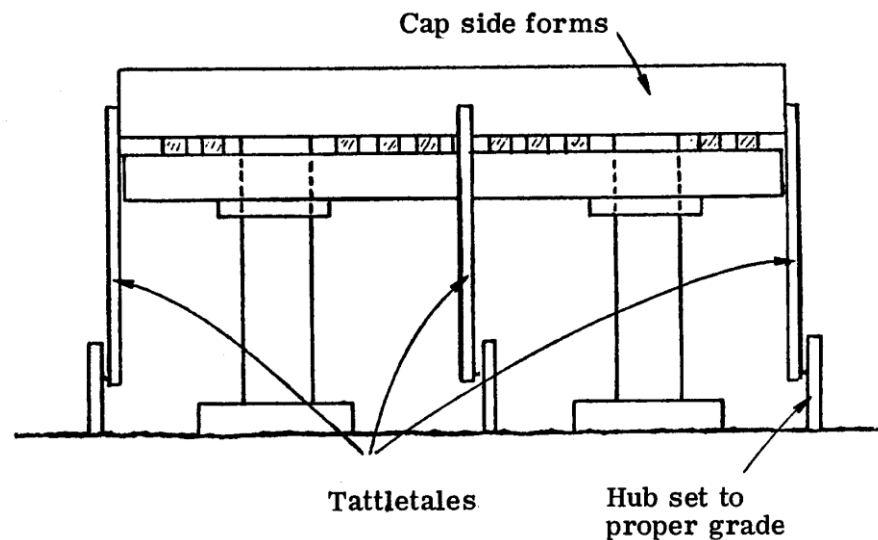

Here is an example of how a tattletale records settlement:

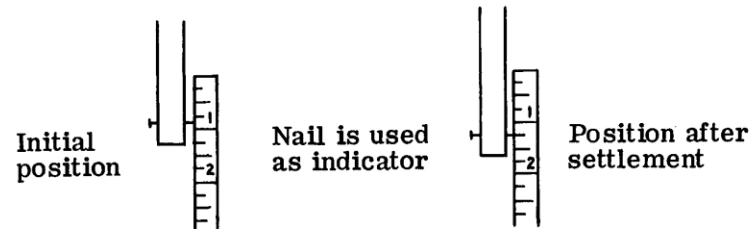

If the tattletales show settlement, one of the following may be responsible:

- The forms or collars may be slipping.
- The forms may be settling into place.
- The support under the forms may not be sufficient.

In most cases, it is not advisable to change elevations. However, you should inform the Contractor of the settlement so that corrective action may be taken to prevent further settlement of the present forms and so that consideration is given to the settlement in future instances.

We will discuss tattletales again when we talk about bridge deck construction.

QUIZ

Who is responsible for setting the forms? _____

What can you use to check vertical and horizontal lines of structures? _____

What is the purpose of attaching tattletales to cap forms? _____

In the diagram below, how much settlement has taken place? _____

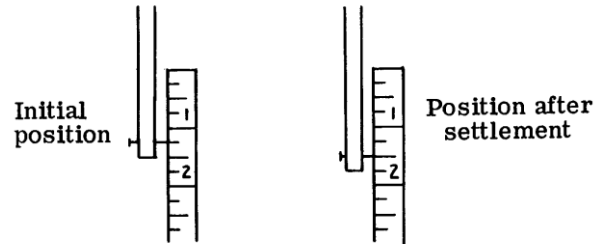

In the case above, what action should you take? _____

REMOVAL OF FALSEWORK AND FORMS

Falsework and forms may be removed when the concrete that they are supporting has cured for a minimum period of time or has a minimum required strength. Refer to **Section 400-14** of the Standard Specifications for these times and strengths. Regardless of whether or not these requirements are met, forms and their supports must not be removed without the approval of the Project Administrator.

When you are inspecting form removal, you should:

- be sure that any honeycombed areas (areas that have air pockets due to insufficient consolidation) are patched properly.
- be sure that no excessive jarring, prying or banging takes place when removing the forms. This can cause hairline cracks or spalling.
- be sure that any holes left by the removal of projecting wire ties or other metal devices are filled with cement mortar (sand, cement and water). This cement mortar should be mixed in the same proportions as that which was used for the concrete contained by the forms.
- be sure that forms that will be reused are handled properly -- that shape, strength, rigidity, water-tightness and surface smoothness are maintained.

QUIZ

As an Inspector, you must ensure four main points during form and falsework removal. Name them.

1.

2.

3.

4.

ANSWERS TO QUESTIONS

Page 5-7

- Forms
- Falsework
- Mudsills
- To hold forms in the proper position
- The friction between the concrete and collar bands
- Rigid
- Forms
- Fresh concrete, Construction equipment, workers
- Contractor
- Elevation, jacks, wedges

Page 5-13

- Vibration
- By supporting the forms with rigid bracing
- They must be mortar-tight
- Beveled, chamfer strips
- They must be counter sunk to prevent them from marring the finished surfaces
- To prevent the concrete from sticking to the forms and to prevent discoloration of the concrete
- It will shrink, causing joints to open in the forms
- So that the corner is not weak and will not chip
- Leave bottom forms loose or make cleanout
- Before the forms are set in place

Page 5-17

- Leak
- Bulges
- Corrode, spall
- Excessive form oil
- Difficult form removal

Page 5-23

- Contractor
- String line and plumb bob
- To check for settlement
- ¼ inch
- Inform the Contractor so that he can take corrective action

Page 5-25

1. Be sure honeycombed areas are patched properly
2. Be sure no jarring, prying or banging occurs that could cause hairline cracking or spalling
3. Be sure small holes are filled with mortar
4. Be sure that forms to be reused are not damaged