



Load Test on Sure-Lock Square Pile Splice

April 24, 2002

Submitted by: Marc Ansley

Table of Contents

Disclaimer	3
Acknowledgements	4
Technical Summary	5
Test Setup	6
Test Results	9
Conclusions	14
References	16

Disclaimer

The opinions, findings and conclusions expressed in this publication are those of the author(s) and not necessarily those of the Florida Department of Transportation (FDOT).

Acknowledgements

This report is the result of the work by a number of individuals none of whom can be blamed for any omissions or inadequacies, which are solely the responsibility of the author.

Tom Beitelman checked the report and made a number of suggestions in particular concerning the test setup. Tony Johnston and David Allen setup the specimen for testing. Steve Eudy setup and ran the data acquisition equipment. Paul Tighe provided documentation of the test. Tony Johnston ran the hydraulic loading equipment.

After the test Tony Johnston and Frank Cobb offered several suggestion on possible improvements to the splice that led to the suggestions contained in the report.

Technical Summary

The Florida Department of Transportation (FDOT) has a need for an effective pile splice that can be completed quickly and provide reasonable section capacity. To this end, National Ventures Inc. provided two forty foot long test specimens (each composed of two twenty foot pieces that were spliced together in the lab) to allow the FDOT Structures Research Center to test the Sure-Lock[®] Pile splice. The Sure-Lock[®] Splice demonstrated an average ultimate flexural capacity of 695 foot-kips. This exceeds the calculated ultimate capacity of the standard FDOT 24-inch pile of 600 foot-kips.

Test Setup

The test arrangement is shown in Figure 1. The locations of the displacement gages along the length of the pile are shown. At the center a gage was provided on each side of the pile so rotation could be accounted for. The piles were loaded with two equal concentrated loads spaced 11'-2" apart as shown.

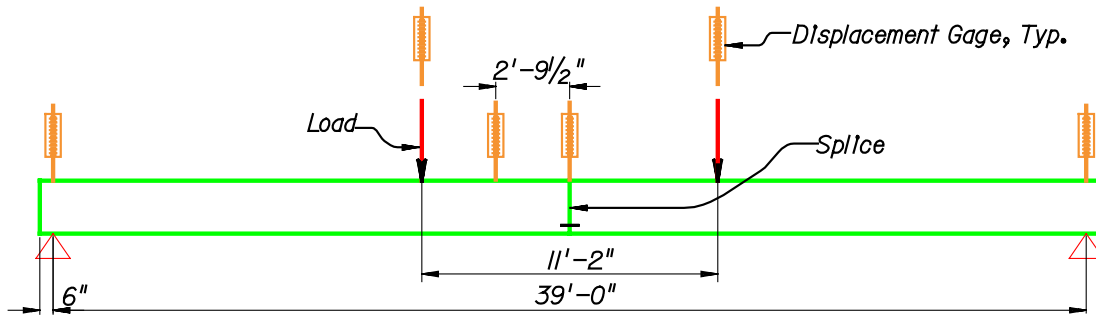

Figure 1

A single actuator provided the two point loads through the use of a steel beam as can be seen in Figure 2. The steel distribution beam was composed of two W 21x68 sections connected together.



Figure 2

The specimens tested were standard FDOT 24 inch piles with 20 - 1/2 inch special low-relaxation strands (area 0.167 in²). The minimum specified concrete strength was 6000

psi. Based on the data provided and the details in Index 624 of the FDOT's Structures Design Office Standards the moment capacity of the section, without axial load, is 600 foot-kips. In addition to the actuator loads, which were measured directly with an inline load cell, determination of the total moment at the center of the pile required inclusion of the weight of the load distribution beam, 3000 pounds, the extra weight due to the splice, 400 pounds and the pile weight which was based on an assumed unit weight of 150 pounds per cubic foot. The 4 ft² cross section of the pile resulted in a uniform weight of 600 pounds per foot. Based on these values the moment at the centerline of the pile prior to application of the actuator loading was:

$$M_{\text{before_loading}} = \frac{0.6 \cdot \frac{\text{kip}}{\text{ft}} \cdot 40 \cdot \text{ft}}{8} \cdot (40 \cdot \text{ft} - 4 \cdot 6 \cdot \text{in}) + \left[1.5 \cdot \text{kip} \cdot \frac{(39 \cdot \text{ft} - 11.1667 \cdot \text{ft})}{2} \right] + \frac{0.4 \cdot \text{kip} \cdot 39 \cdot \text{ft}}{4}$$

$$M_{\text{before_loading}} = 138.775 \text{ ft kip}$$

The splice is composed of 3 components, a male end, shown in Figure 3, a female end, shown in Figure 4 and the locking bars, also shown in Figure 4.



Figure 3



Figure 4

The locations of the # 10 reinforcing bars, the prestressing and the groove for the locking bars are noted in Figure 3. The reinforcing bars extend up to 7 feet into the pile to compensate for the development length of the strands.

According to the manufacturer, the female and male splice sections are built from ASTM A572 Grade 50 plate and the locking bars are composed of cold finished ASTM A108 bar.

The splice was put together for the test by supporting the two 20 foot long sections horizontally and sliding them together and then inserting the locking bars. A moderate amount of force, a few blows with a ball peen hammer, was required to fully insert some of the locking bars. This was probably due to the horizontal orientation the splice. It is anticipated that the normal vertical orientation of the piles in the field would not require this effort.

Test Results

Two static tests were conducted. Shown in Figures 5 and 6 are the resulting graphs depicting deflection at the splice versus the corresponding moment. The discontinuity near the peak in Figure 5 is because the displacement gages had to be reset since the range was exceeded. This problem was corrected in the second test. Note that in both graphs the moment at 0 inches of deflection is 138.775 foot-kips.

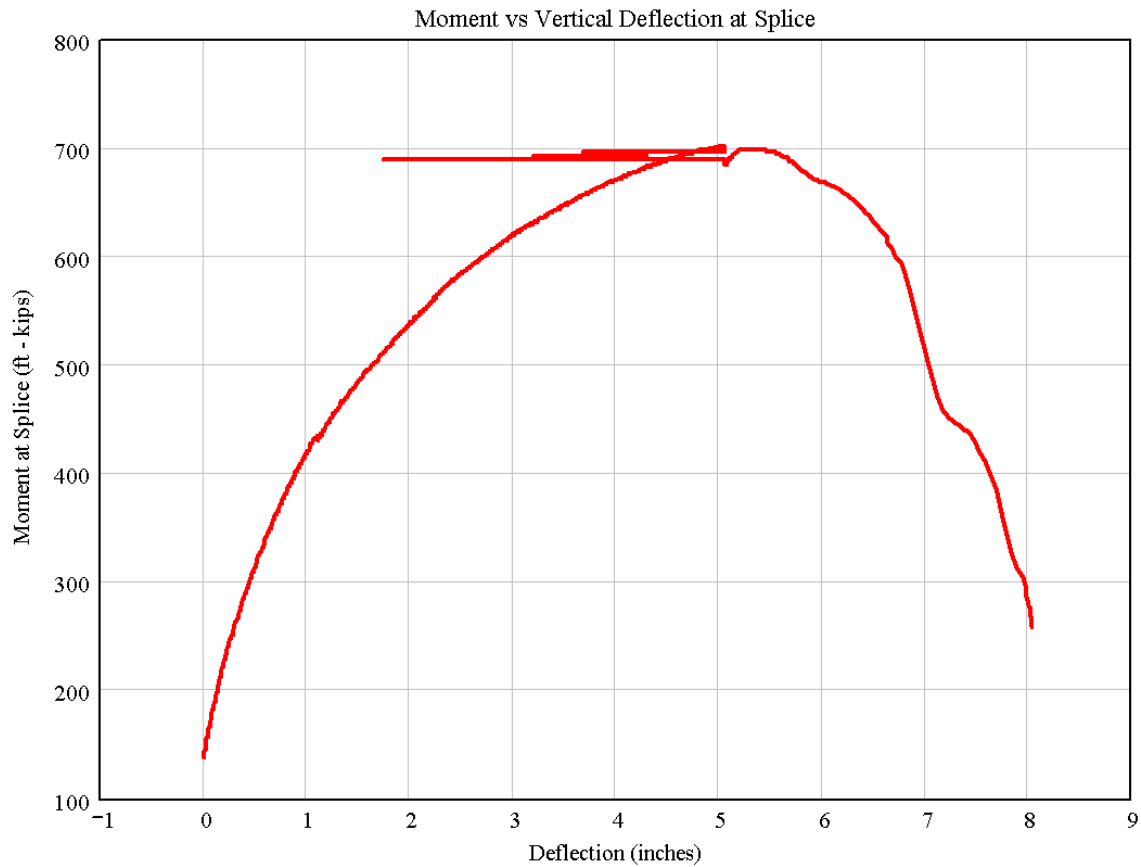

Figure 5

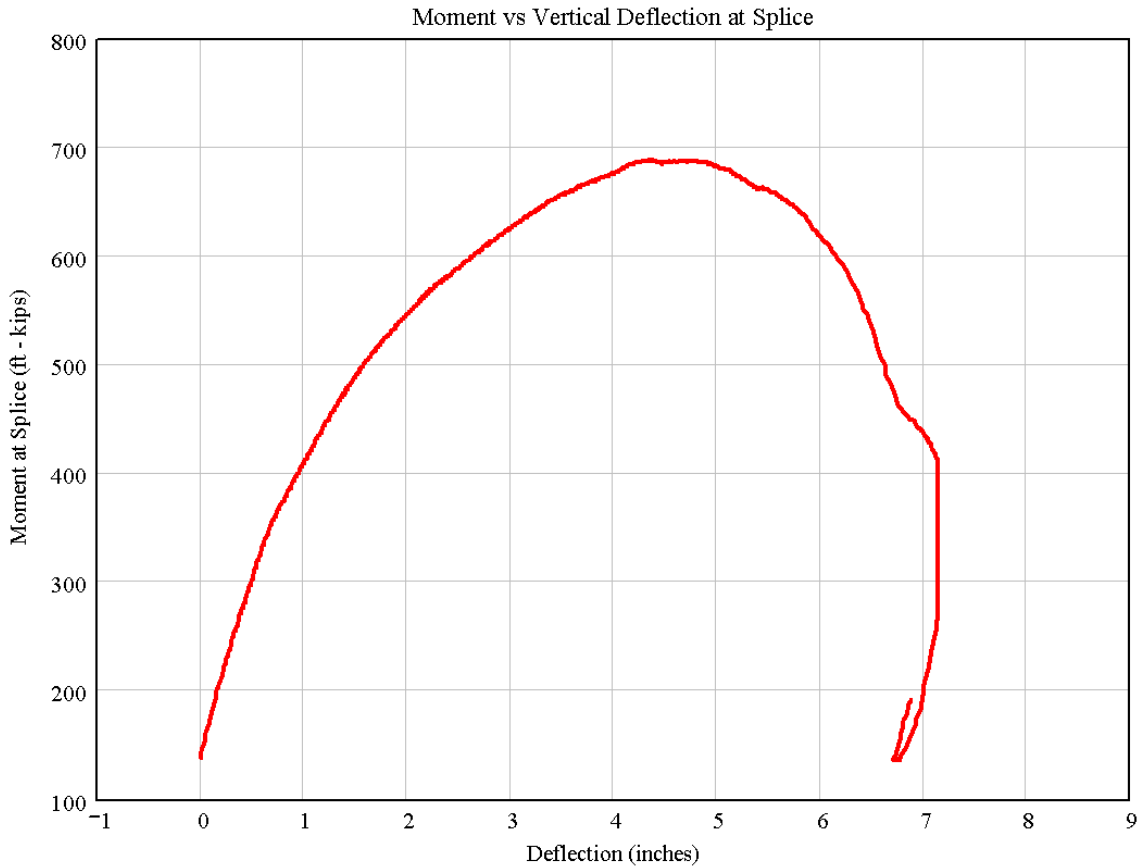

Figure 6

The peak moment values for the two tests are given in Table 1.

Table 1

Test Number	Peak Moment Capacity (foot-kips)
1	701.3
2	688.7

The specimens were limited in capacity by the splice. Figure 7 and Figure 8 show the condition of the splice at the conclusion of testing. The relative displacement between the halves of the splice is evident. This displacement is due to the rotation of the ring bar that comprises the female section of the splice. It is believed that the rotation of this section allowed the lock bars to slip out of the groove formed by the joining of the splice halves. The male section of the splice did not rotate since that would require bending a 2 inch plate with an effective cantilever of 1.1 inches over an 18.5 inch width. The torsional

stiffness of the ring bar in the female section over an unsupported length of 18.6 inches is significantly less.



Figure 7

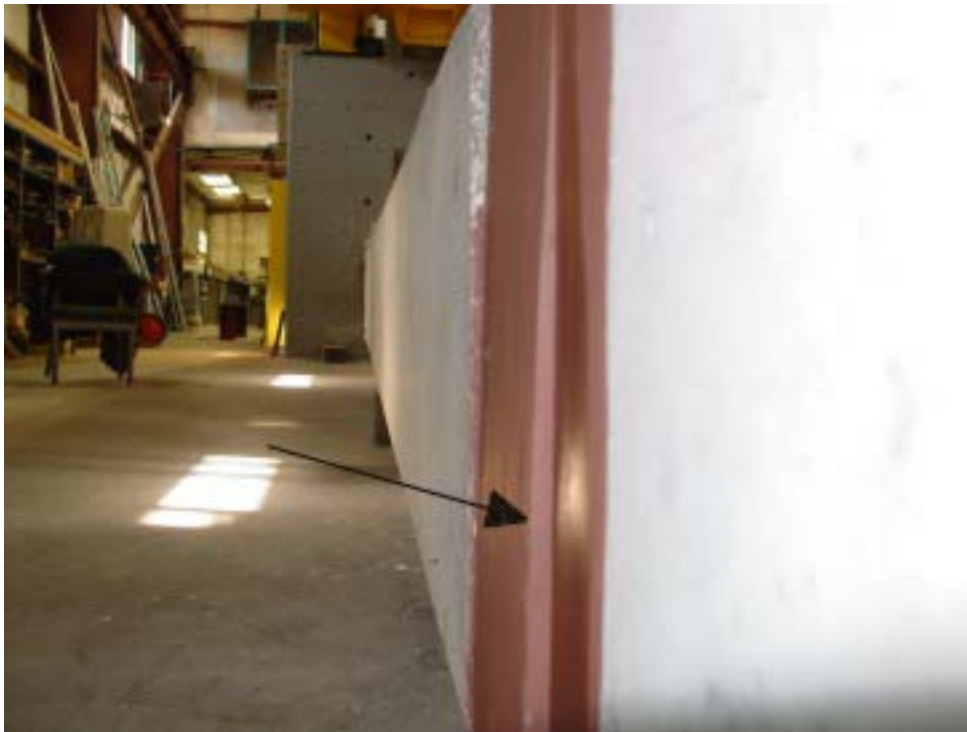

Figure 8

The rotation of the female section of the splice was the limiting component of the splice moment capacity. However, another aspect of concern was the behavior of the concrete

section of the pile adjacent to the female half of the splice. Figure 9 shows the cracking on the side of the pile with the female splice section. This can be contrasted with Figure 10, which shows the cracking on the male side of the splice.



Figure 9



Figure 10

The number 10 reinforcing bars provided with the splice are straight on the male side of the splice but are bent on the female side. The configuration of the number 10 bars in the female portion can be seen, in elevation, in Figure 11. These bends are provided so that the reinforcing will have sufficient cover outside the splice region. This bend detail requires attention to tie placement to offset the bursting forces generated by this pattern. It is believed that this bar detail along with the lack of sufficient tie reinforcing led to the development of the crack pattern shown in Figure 9. This cracking was significant enough to indicate that it would have limited the capacity of the section if the splice had not failed first.

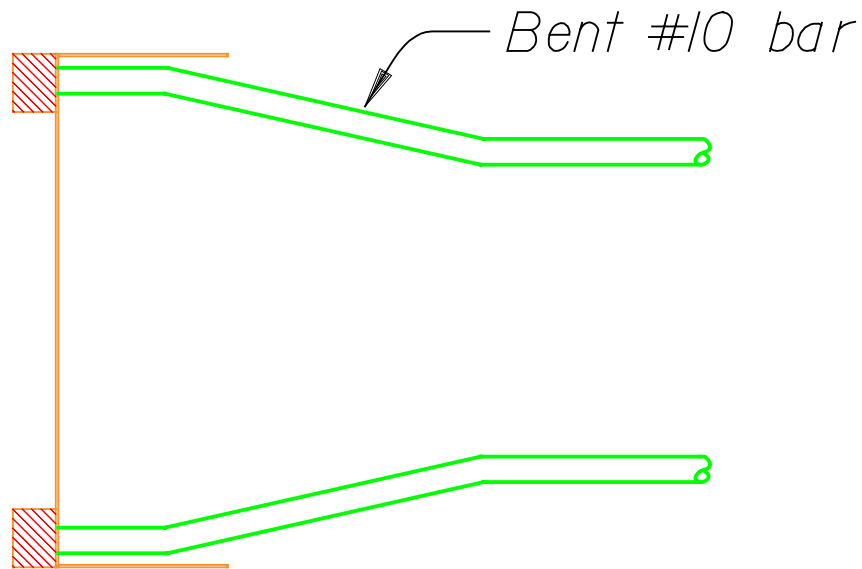

Figure 11

Conclusions

The Sure-Lock[®] splice demonstrated a capacity in excess of 600 foot-kips. The average moment capacity for the two tests is 695 foot-kips. Even though it easily met the Department's minimum strength requirements, it is believed the capacity of the splice could be significantly enhanced with a few modifications to the female half. Shown in Figures 12 and 13 are two different suggestions on how the splice might be modified.

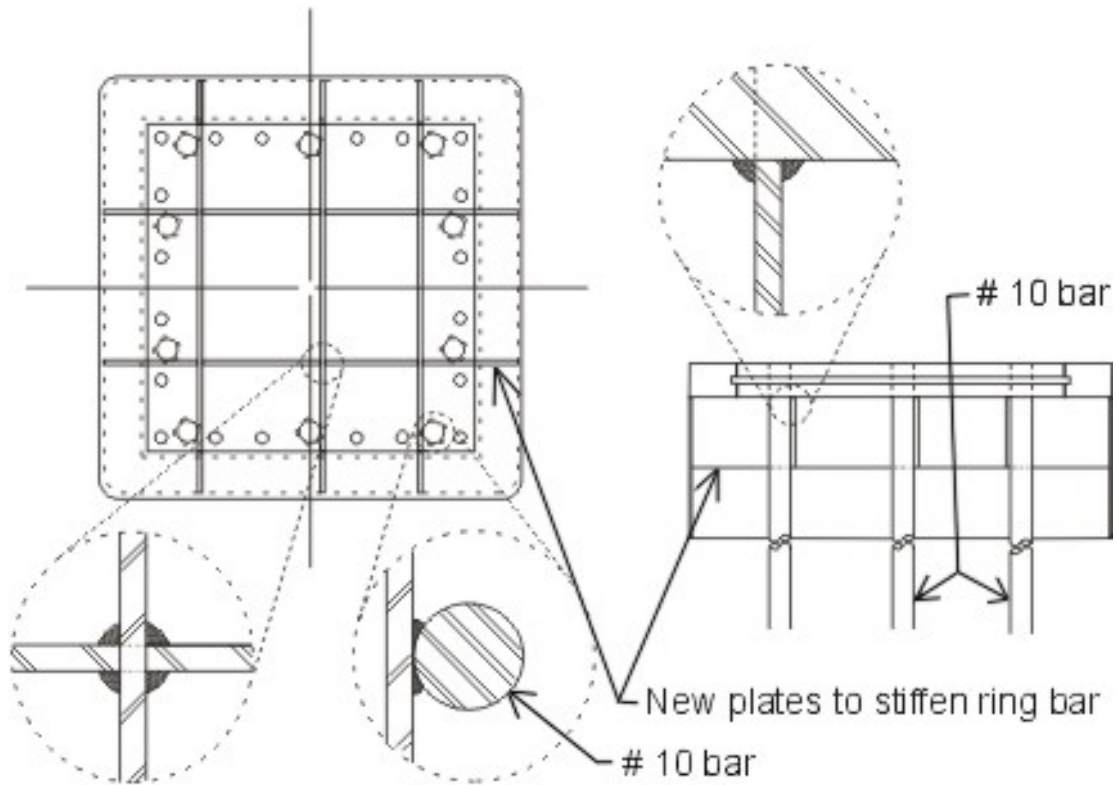

Figure 12

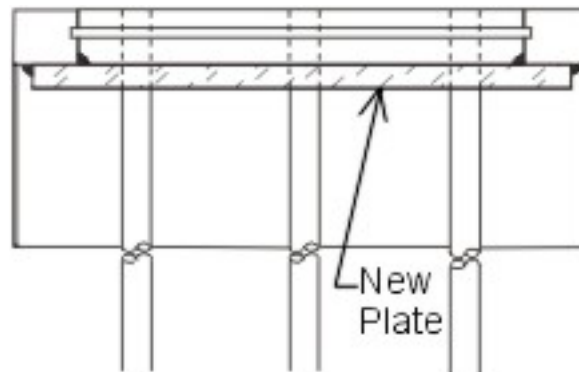

Figure 13

In Figure 12 a grid of plates is added to the splice to torsionally stiffen the ring bar and provide a means of connecting straight reinforcing. In Figure 13, a plate is added behind the ring bar that would also improve its torsional capacity and allow the use of straight reinforcing.

If changes of this nature are not made and the splice continues to use bent reinforcing on the female side it is suggested that more attention be given to providing additional confinement ties at the bends in the number 10 reinforcing.

References

- 1) FDOT Structures Design Office – 2002.3 English Standard Drawings
4/1/2002
- 2) Private communication with Glenn Lockie of National Ventures Inc.