

SECTION DD

RECOMMENDED MAXIMUM PIPE SIZES

Inlet Inside Width	Pipe Size
2'-0"	18"
3'-1"	24" 18" Where An 18" pipe Enters A 2'-0" Wall

Note: Recommended sizes are for concrete pipe. Sizes for other types of pipe must be verified for fit in accordance with Index No. 201. For larger pipe see bottom detail right and Index No. 200.

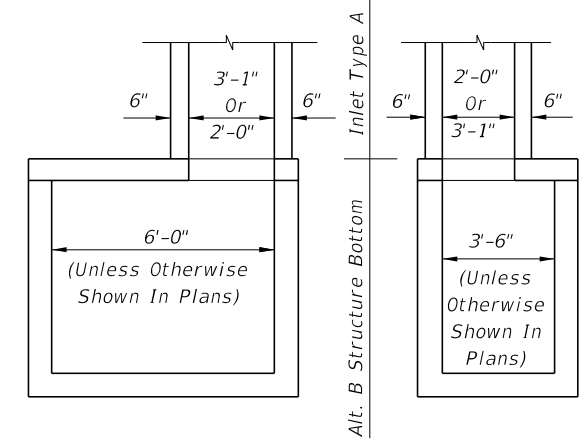

NOTE: Alt. B Structure Bottom Only. See Index No. 200 for Structure Bottom Details And Hole Reinforcement.

INLET WITH STRUCTURE BOTTOM

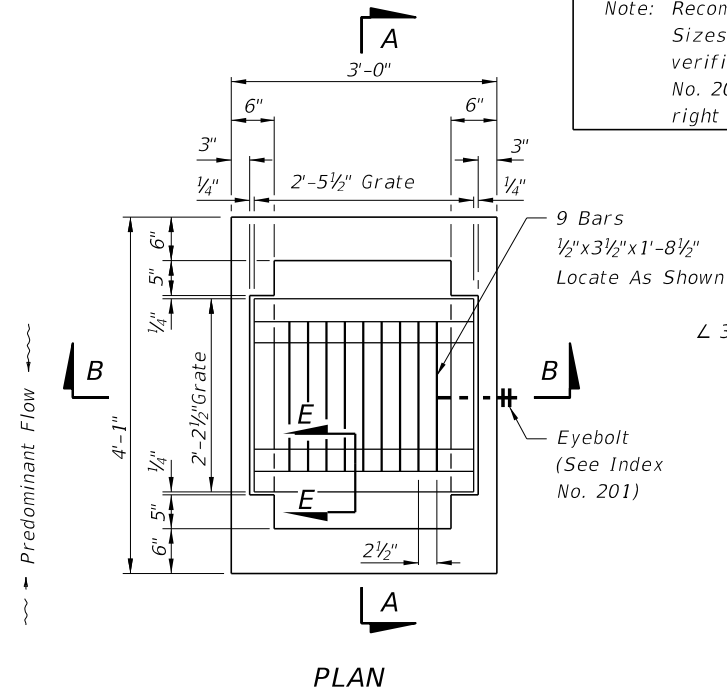
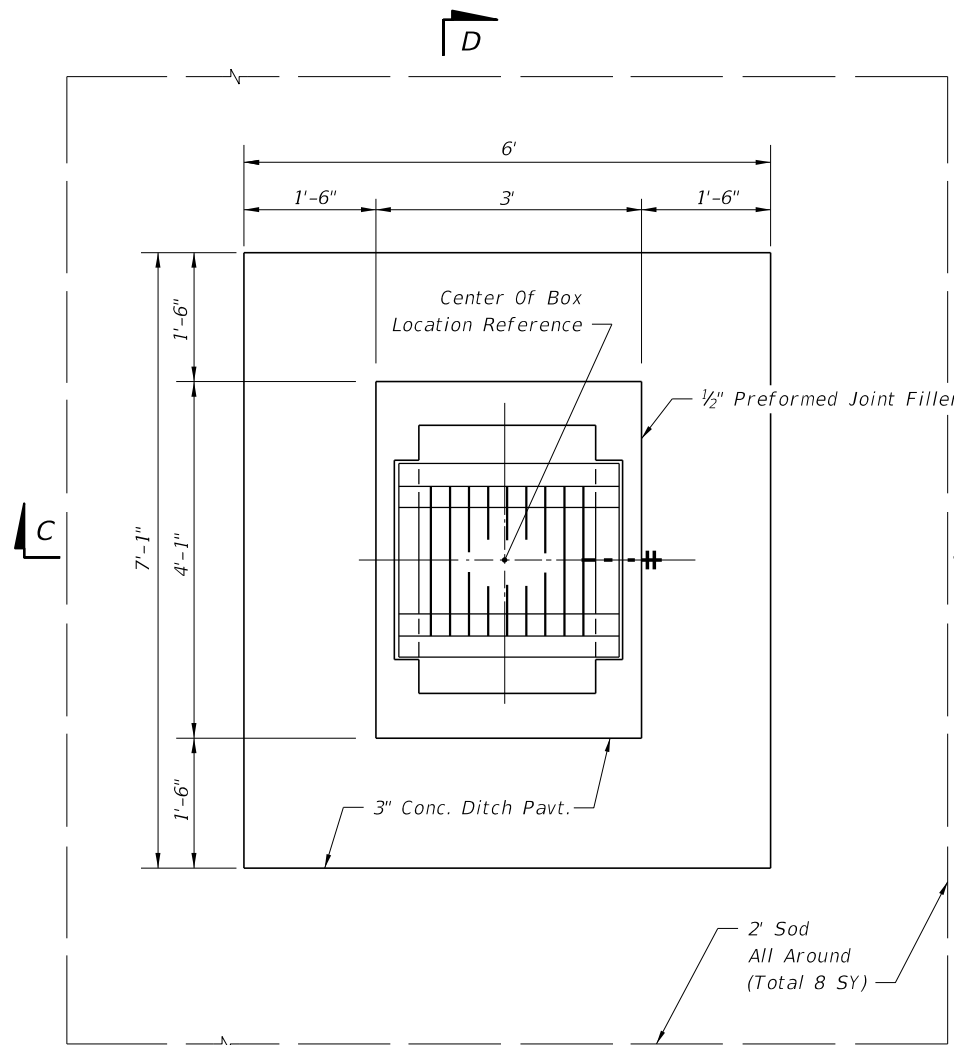

PLAN

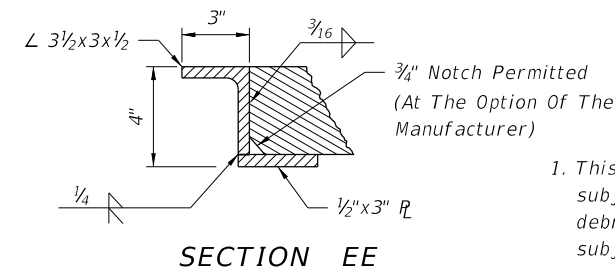

SECTION EE

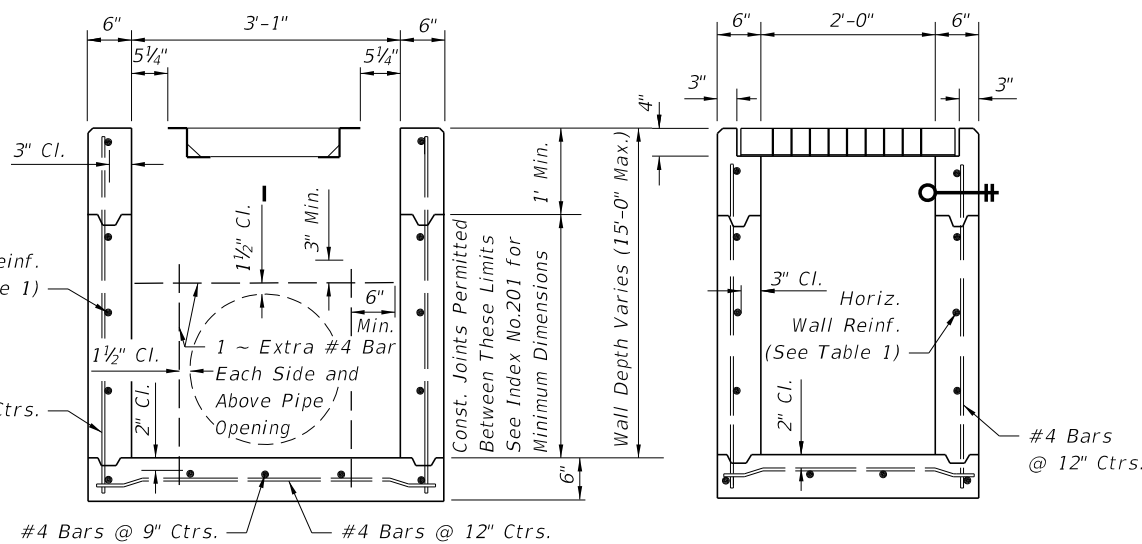

(Pipe Opening Shown) SECTION AA

(Pipe Opening Not Shown) SECTION BB

GENERAL NOTES

- This inlet is designed for ditches, medians, or other area subject to heavy wheel loads on limited access facilities where debris may be a problem. This inlet is not for use in areas subject to pedestrian and/or bicycle traffic.
- All reinforcing is Grade 60 bars with 2" min. cover unless otherwise noted. Cut or bend bars out of way of pipe to clear pipe by 1 1/2". See Index 201 for equivalent area of welded wire fabric.
- All exposed edges and corners shall be 3/4" chamfer or tooled to 1/4" radius.
- When alternate "G" grate is specified in plans, the grate is to be hot-dip galvanized after fabrication.
- Cost of ditch paving to be included in the cost of Inlet. Sodding to be paid for under contract unit price for Performance Turf, SY.
- For supplemental details see Index No. 201.
- All dimensions are for both precast and cast-in-place inlets unless otherwise noted.
- Inlet to be paid for under the contract unit price for inlets (Dt Bot Type A), EA.

HORIZONTAL WALL REINFORCING SCHEDULE (TABLE 1)

WALL DEPTH	SCHEDULE	AREA (in. ² /ft.)	MAX. SPACING	
			BARS	WWF
0' - 10'	A12	0.20	12"	8"
10' - 15'	A6	0.20	6"	5"

6/8/2015 9:30:14 AM

LAST REVISION	DESCRIPTION:
07/01/09	

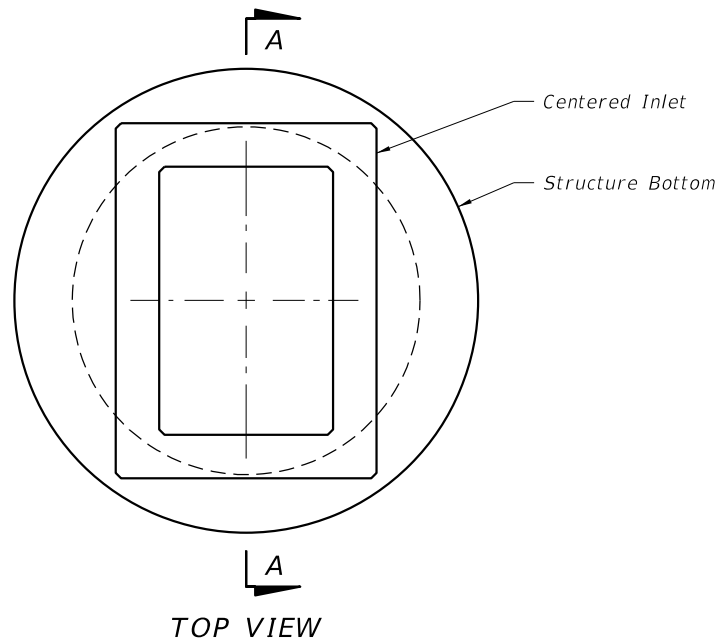

TOP SLAB OPENINGS	
DIAMETER	OPENING SIZE
	MIN.
4'-0" To 8'-0"	2'-0" x 3'-1"

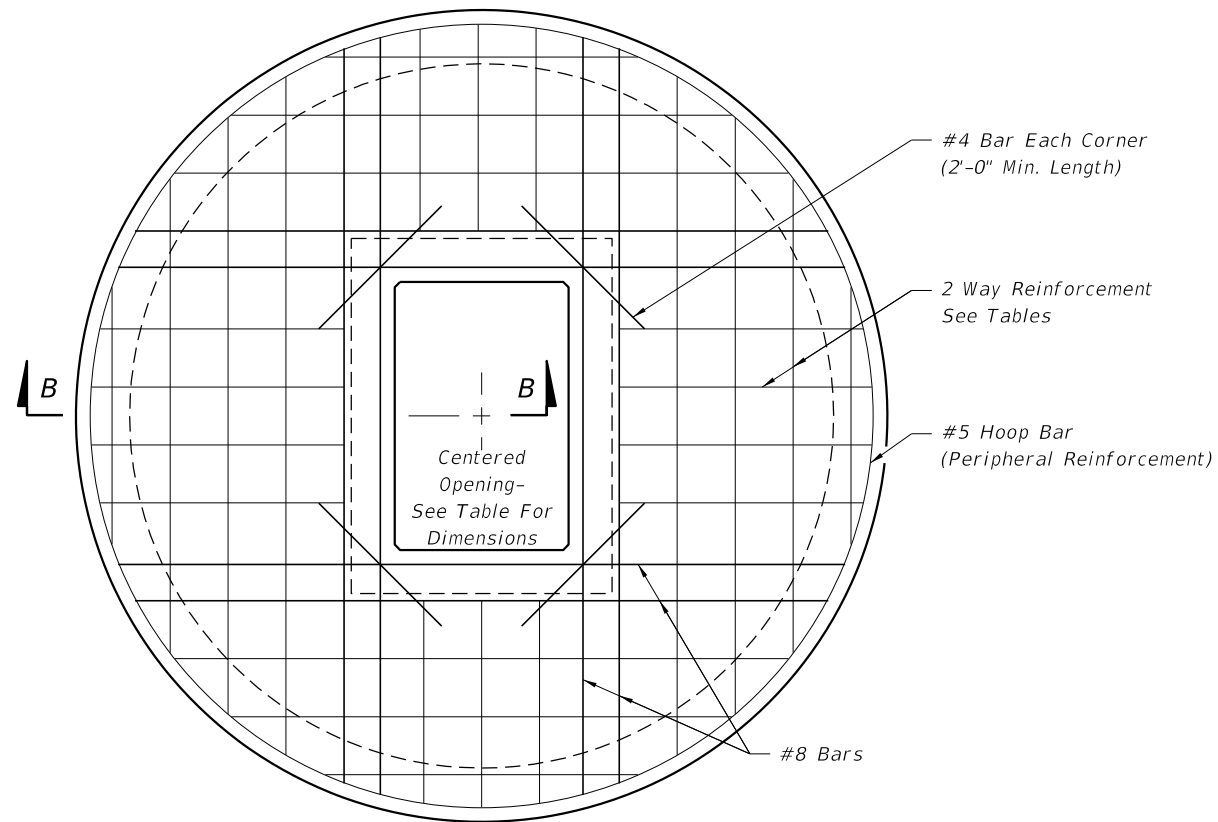
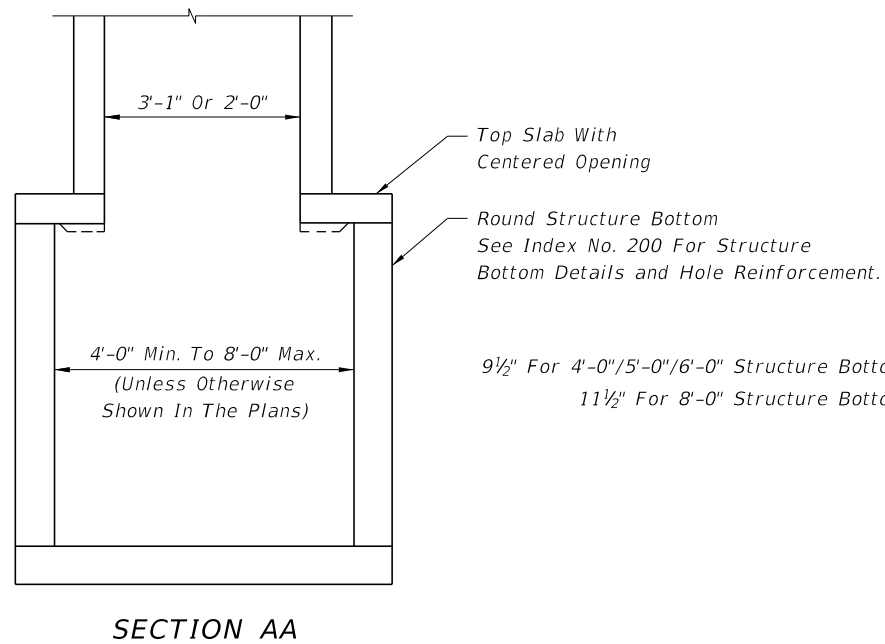

TOP SLAB REINFORCING DIAGRAM

TOP SLAB REINFORCING SCHEDULE	
SCHEDULE	GRADE 60 (BAR) OR 65 KSI & 70 KSI (WIRE FABRIC) In. ² /ft.
A	0.20
B	0.24
C	0.37
D	0.53
E	0.73
F	1.06
G	1.45

TOP SLAB WITH CENTERED OPENING		
SLAB DEPTH	SLAB THICKNESS	REINFORCING (2 WAYS) SCHEDULE
SIZE: 4'-0"		
≥0.5'-40'	9½"	C
SIZE: 5'-0"		
≥0.5'<30'	9½"	C
30'-40'	9½"	D
SIZE: 6'-0"		
0.5'<8'	9½"	B
8'<18'	9½"	C
18'<30'	9½"	D
30'<37'	9½"	E
37'-40'	9½"	G
SIZE: 8'-0"		
≥0.5'<9'	11½"	C
9'<15'	11½"	D
15'<23'	11½"	E
23'<33'	11½"	E
33'-40'	11½"	G

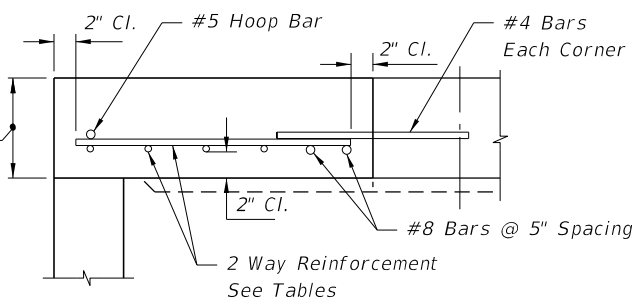

SECTION BB

ALT. A STRUCTURE BOTTOM FOR INLET TYPE A

6/8/2015 9:30:14 AM

LAST REVISION 07/01/07	DESCRIPTION:
---------------------------	--------------